

# DECO Clim

MONTAGE



- 7016
- 9010
- 9001
- 1015

100% Aluminium

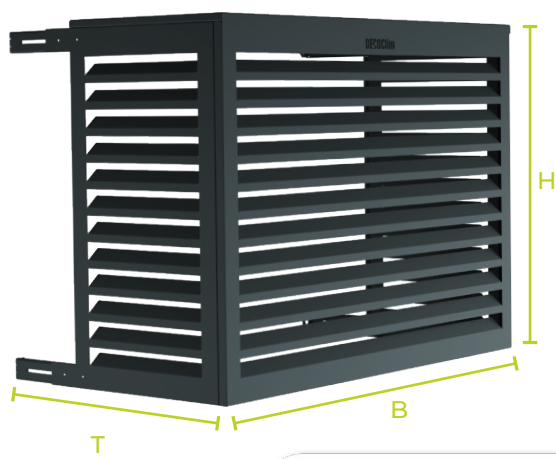

100 % ALUMINIUM - Umweltfreundliche Pulverbeschichtung - Wartungsfrei  
**10 JAHRE GARANTIE**



**Mindestens 7 cm zurückgesetzt**  
 Erlaubt eine optimale Luftzirkulation

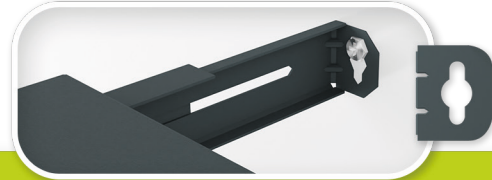

**Lässt sich leicht befestigen und abnehmen**  
 Knopflochsystem

## ZUBEHÖR

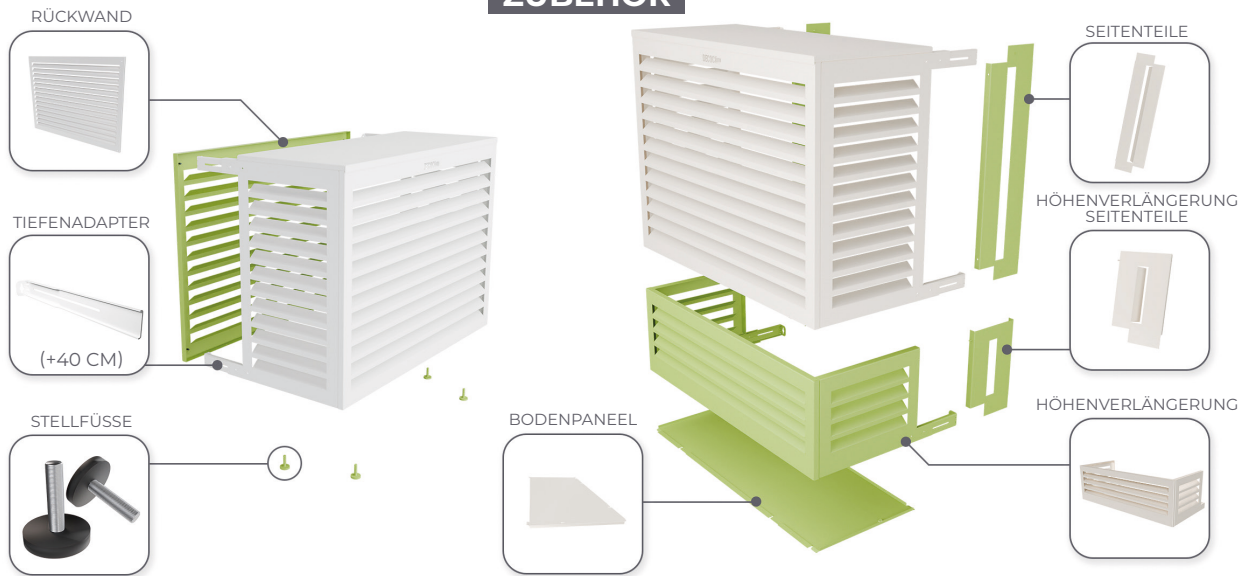

	Innenabmessungen	Außenabmessungen	Gewicht	Paketabmessungen	Paketgewicht
<b>XS</b>	H 60 x B 75 x T 40-55 cm	H 61 x B 79 x T 41-56 cm	6,3 kg	75 x 95 x 9 cm	7,3 kg
<b>S</b>	H 68 x B 90 x T 45-60 cm	H 69 x B 94 x T 46-61 cm	8,2 kg	75 x 100 x 8,5 cm	9,2 kg
<b>S+</b>	H 30 x B 90 x T 45-60 cm	H 31 x B 94 x T 46-61 cm	3,6 kg	75 x 100 x 8,5 cm	4,6 kg
<b>M</b>	H 85 x B 105 x T 51-66 cm	H 86 x B 109 x T 52-67 cm	11 kg	55 x 114,5 x 11,5 cm	12 kg
<b>M+</b>	H 40 x B 105 x T 51-66 cm	H 41 x B 109 x T 52-67 cm	4,5 kg	55 x 115,4 x 11,5 cm	5,5 kg
<b>L</b>	H 95 x B 110 x T 55-70 cm	H 96 x B 114 x T 56-71 cm	13 kg	62 x 121 x 11,5 cm	14 kg
<b>L+</b>	H 55 x B 110 x T 55-70 cm	H 55 x B 114 x T 56-71 cm	6,4 kg	62 x 121 x 11,5 cm	7,4 kg
<b>XL</b>	H 120 x B 131 x T 65-80 cm	H 121 x B 135 x T 66-81 cm	18 kg	69 x 141 x 12,5 cm	19 kg
<b>XL+</b>	H 50 x B 131 x T 65-80 cm	H 51 x B 135 x T 66-81 cm	6,5 kg	57,5 x 142,5 x 8 cm	7,5 kg
<b>XXL</b>	H 100 x B 150 x T 85-100 cm	H 101 x B 154 x T 86-101 cm	22 kg	94 x 160 x 12,5 cm	24 kg
<b>XXL+</b>	H 50 x B 150 x T 85-100 cm	H 51 x B 154 x T 86-101 cm	10 kg	56 x 160 x 8 cm	11 kg

**Wichtig: Eine „+“-Größe besteht aus einer Standardgröße + ihrer Höhererweiterung**  
 Beispiel: S+ = [Größe S] + [Höhererweiterung S+] = 2 Pakete (1 [Paket S] + 1 [Paket S+])



8003

8012

9005

7022

7037

7035

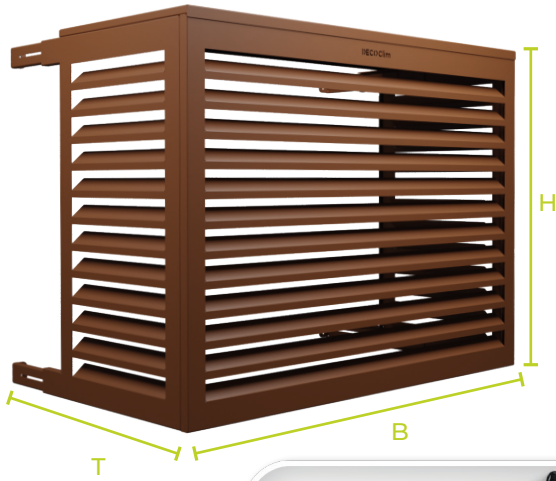

100 % ALUMINIUM - Umweltfreundliche Pulverbeschichtung - Wartungsfrei  
**10 JAHRE GARANTIE**



**Mindestens 7 cm zurückgesetzt**  
 Erlaubt eine optimale Luftzirkulation

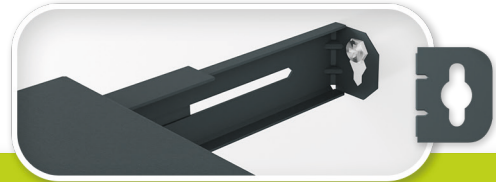

**Lässt sich leicht befestigen und abnehmen**  
 Knopflochsystem

## ZUBEHÖR

RÜCKWAND



STELLFÜSSE

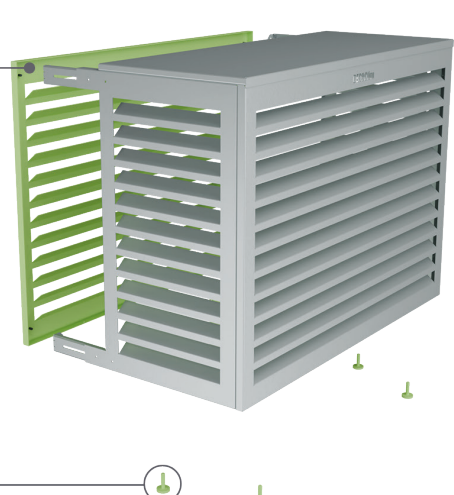

BODENPANEEL

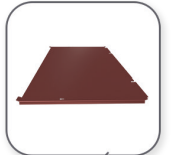

	Innenabmessungen	Außenabmessungen	Gewicht	Paketabmessungen	Paketgewicht
<b>S</b>	H 68 x B 90 x T 45-60 cm	H 69 x B 94 x T 46-61 cm	8,2 kg	75 x 100 x 8,5 cm	9,2 kg
<b>M</b>	H 85 x B 105 x T 51-66 cm	H 86 x B 109 x T 52-67 cm	11 kg	55 x 114,5 x 11,5 cm	12 kg
<b>L</b>	H 95 x B 110 x T 55-70 cm	H 96 x B 114 x T 56-71 cm	13 kg	62 x 121 x 11,5 cm	14 kg
<b>XL</b>	H 120 x B 131 x T 65-80 cm	H 121 x B 135 x T 66-81 cm	18 kg	69 x 141 x 12,5 cm	19 kg



# DECO Clim

Innovation liegt in der Luft



VIDEO

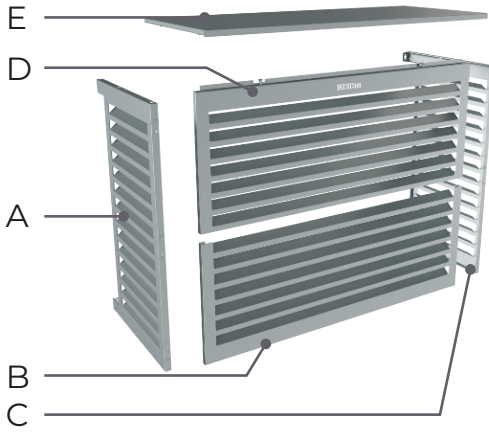

Bei der Grösse S besteht die Vorderseite aus einem Teil

## MONTAGE ALU S BIS XL

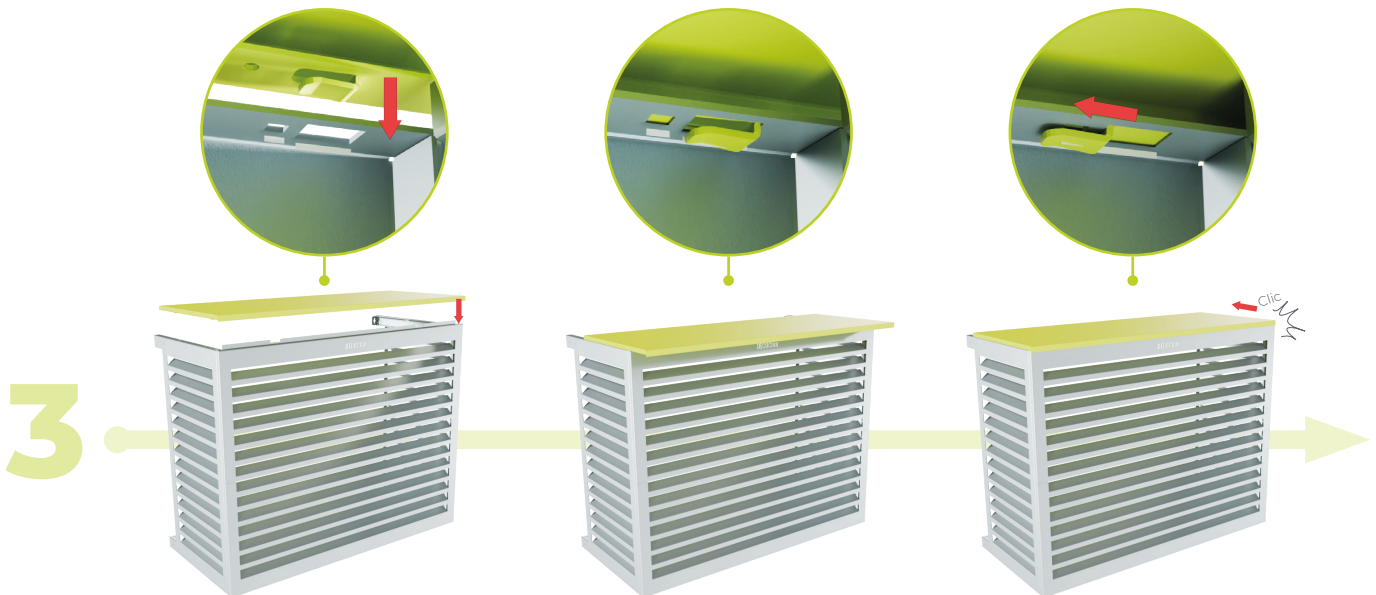
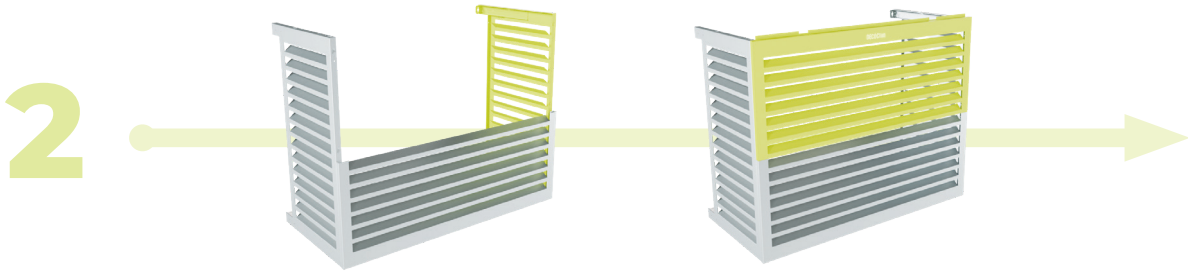
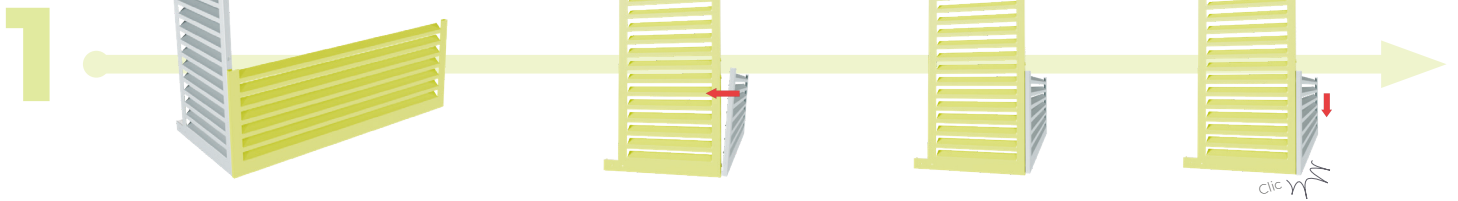



VIDEO



x1

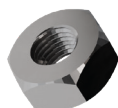

x4

## MONTAGE RÜCKSEITE

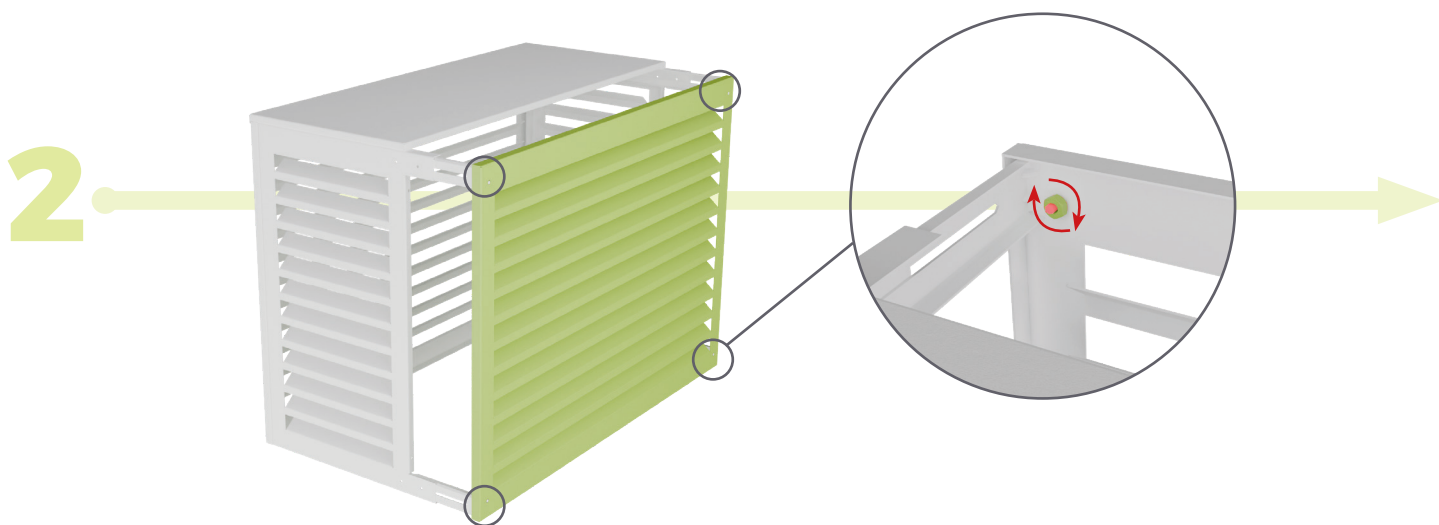
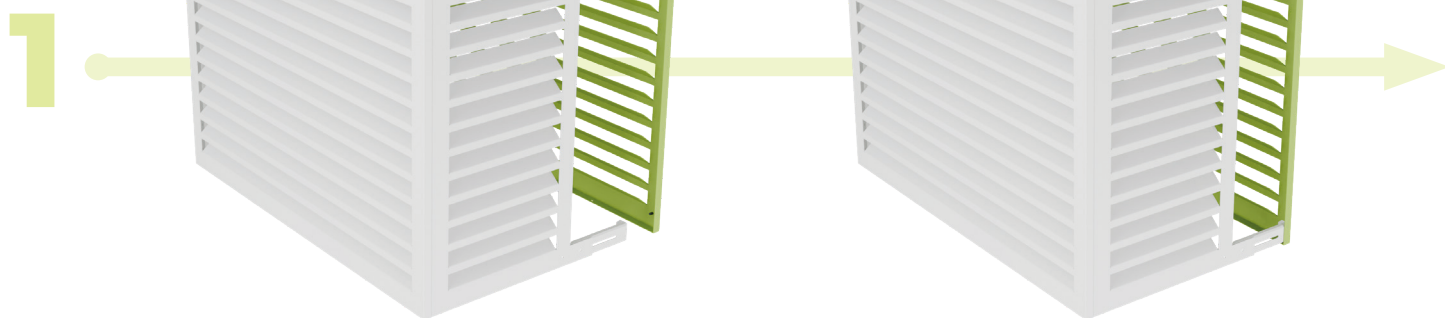

FR



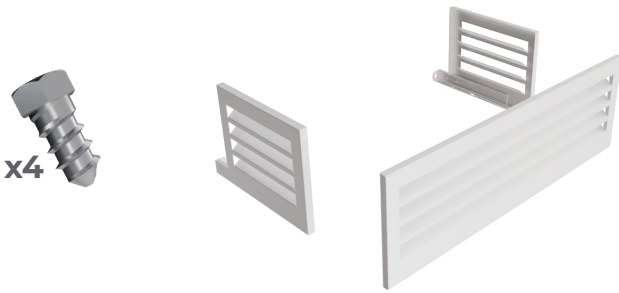

## HÖHENERWEITERUNG

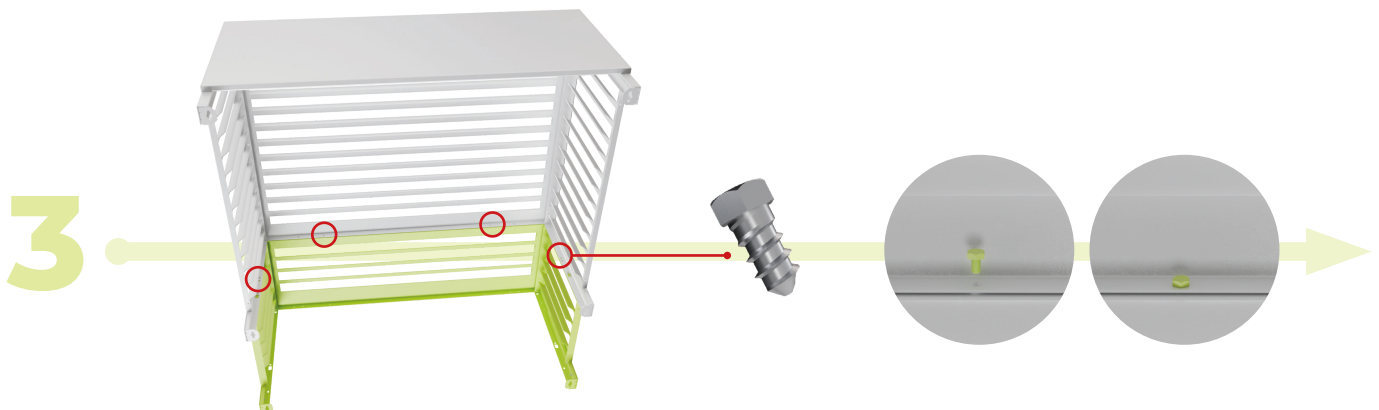
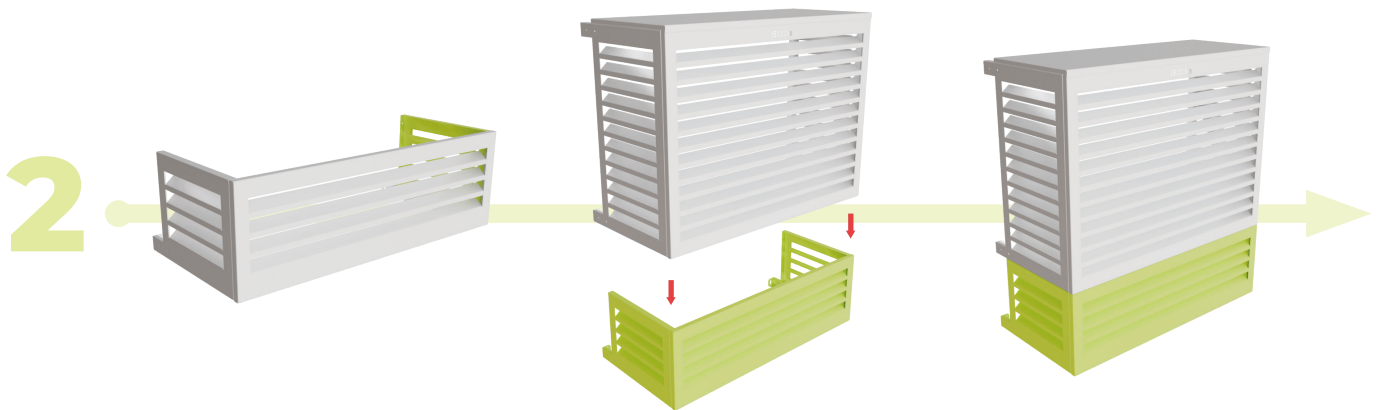
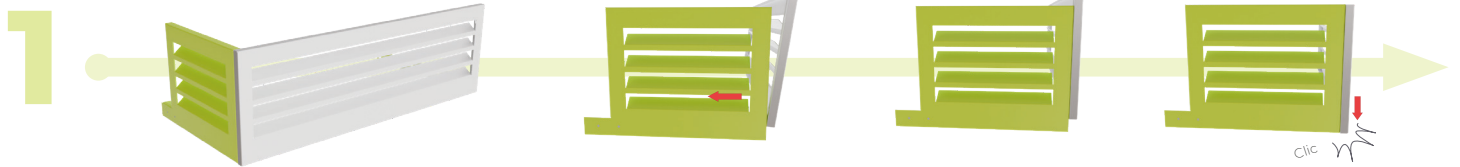
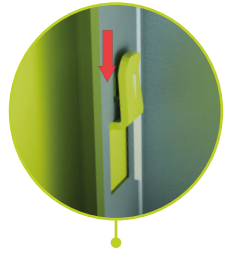
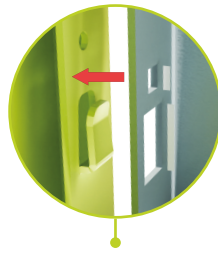



VIDEO



x1

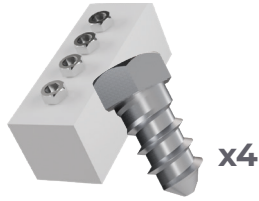

x4

## UNTERSEITE

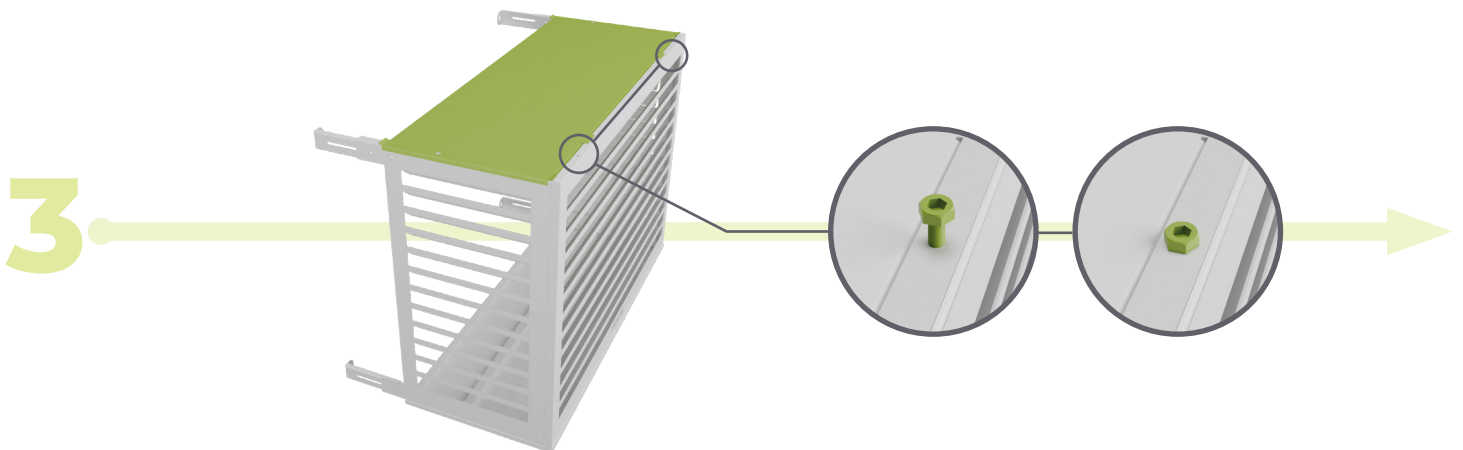
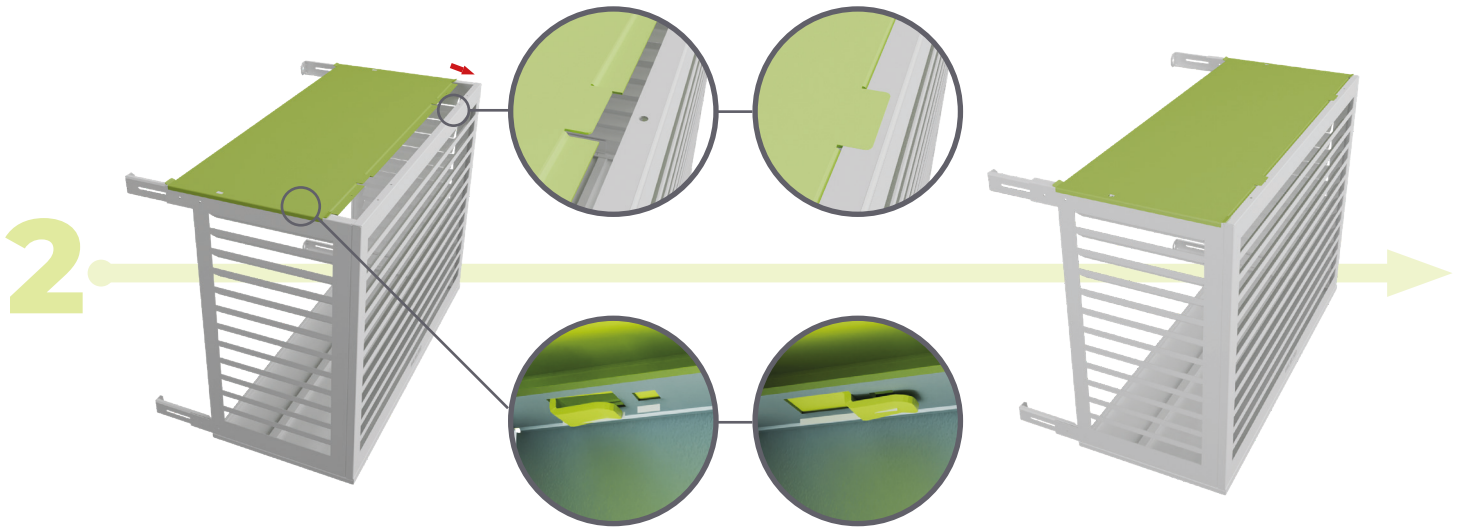
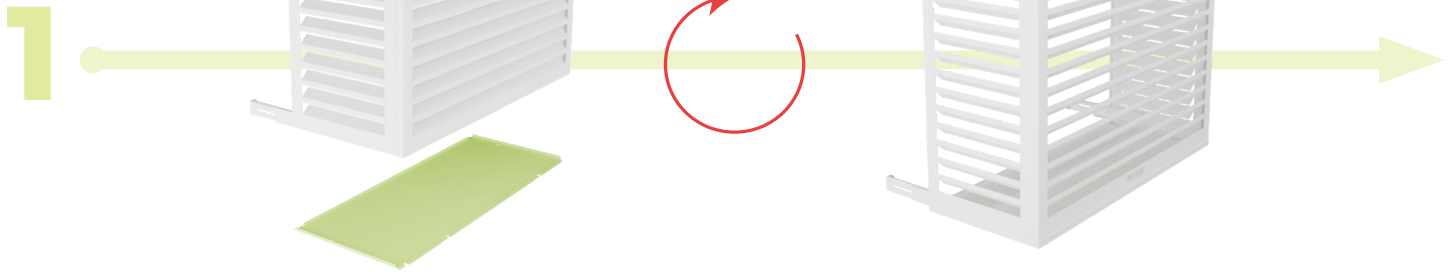

FR





VIDEO



x2

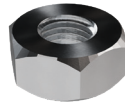

x4

## SEITENTEILE / PANEELS

1

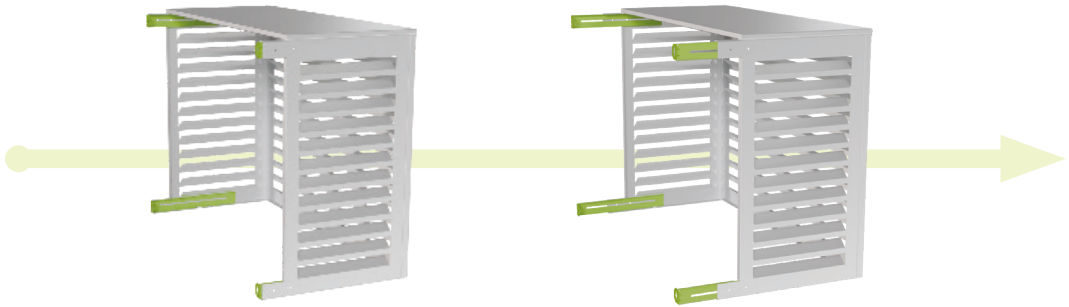

2

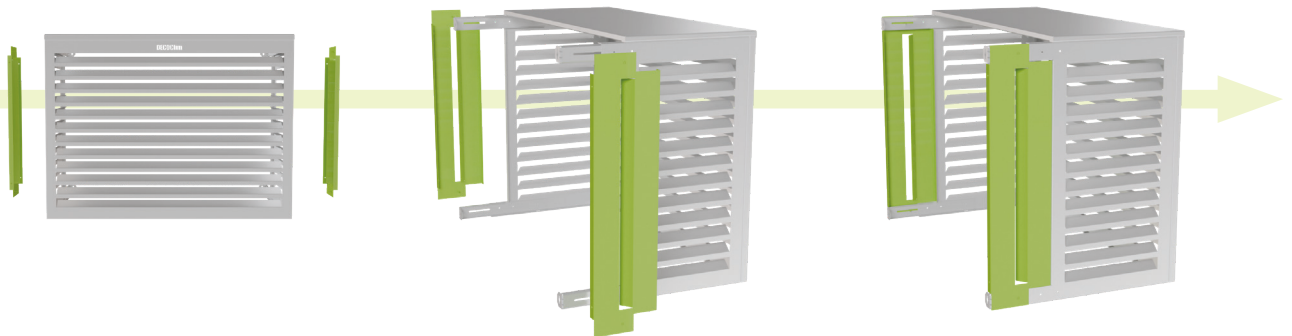

3

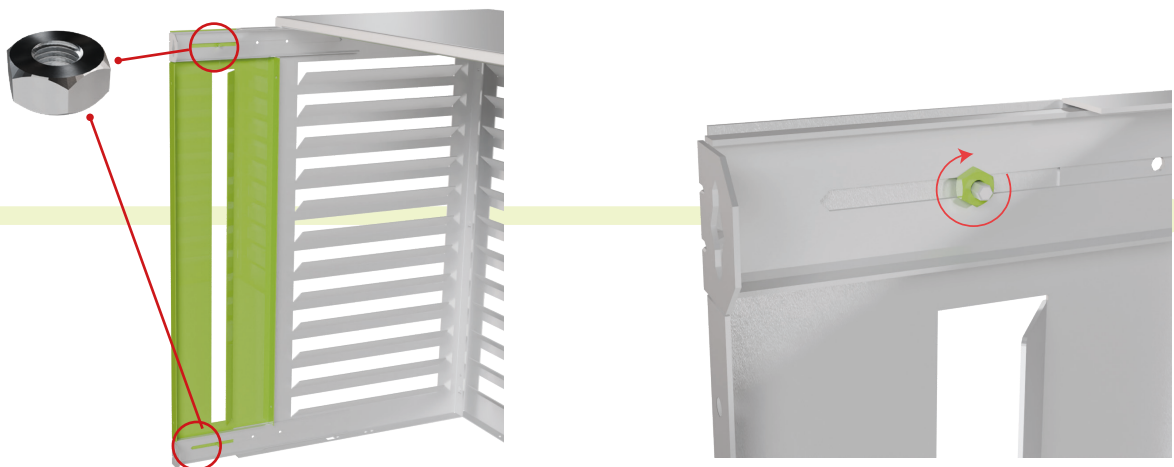



VIDEO

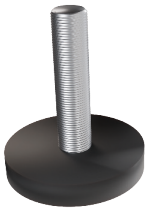

x4

## STELLFÜSSE 1 BIS 3 cm

1

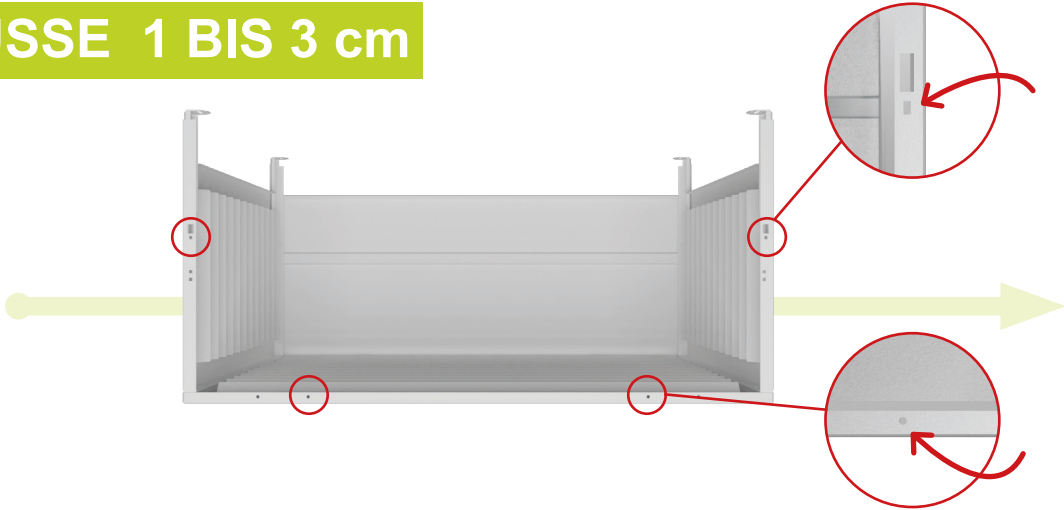

2

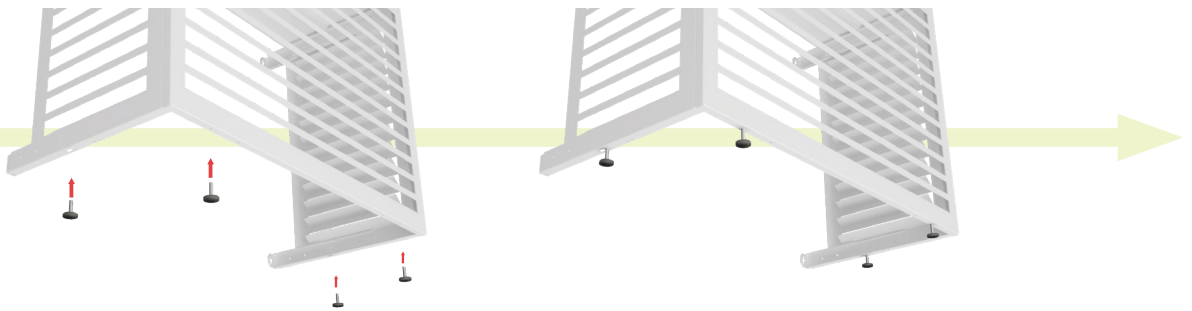

3





100% Holz (Eukalyptus)



**2 JAHRE GARANTIE**



**Mindestens 7 cm**

Erlaubt eine optimale Luftzirkulation



**Lässt sich leicht befestigen und abnehmen**

Knipflochsystem

## ZUBEHÖR

RÜCKWAND



BODENPANEEL



TIEFEN-/FUSS-SET

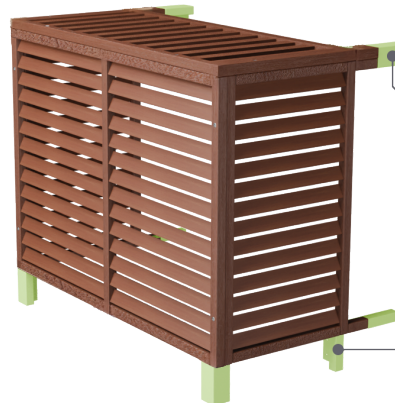

	Innenabmessungen	Außenabmessungen	Gewicht	Paketabmessungen	Paketgewicht
<b>S</b>	H 68 x B 90 x T 45 cm	H 70,5 x B 95 x T 47,5 cm	12,3 kg	72 x 100 x 9 cm	14,5 kg
<b>M</b>	H 83,5 x B 105 x T 51 cm	H 86 x B 110 x T 53,5 cm	16 kg	87 x 114 x 9 cm	18,5 kg
<b>L</b>	H 95 x B 100 x T 51 cm	H 97,5 x B 105 x T 53,5 cm	16,5 kg	98 x 110 x 9 cm	19 kg
<b>XL</b>	H 117 x B 125 x T 61 cm	H 119,5 x B 130 x T 63,5 cm	27,5 kg	69 x 136 x 14 cm	30 kg

# DECO Clim

Innovation liegt in der Luft



x10 (M6x35 mm)

x8 (M4x15 mm)

x1

x2



VIDEO



## MONTAGE HOLZHAUBE

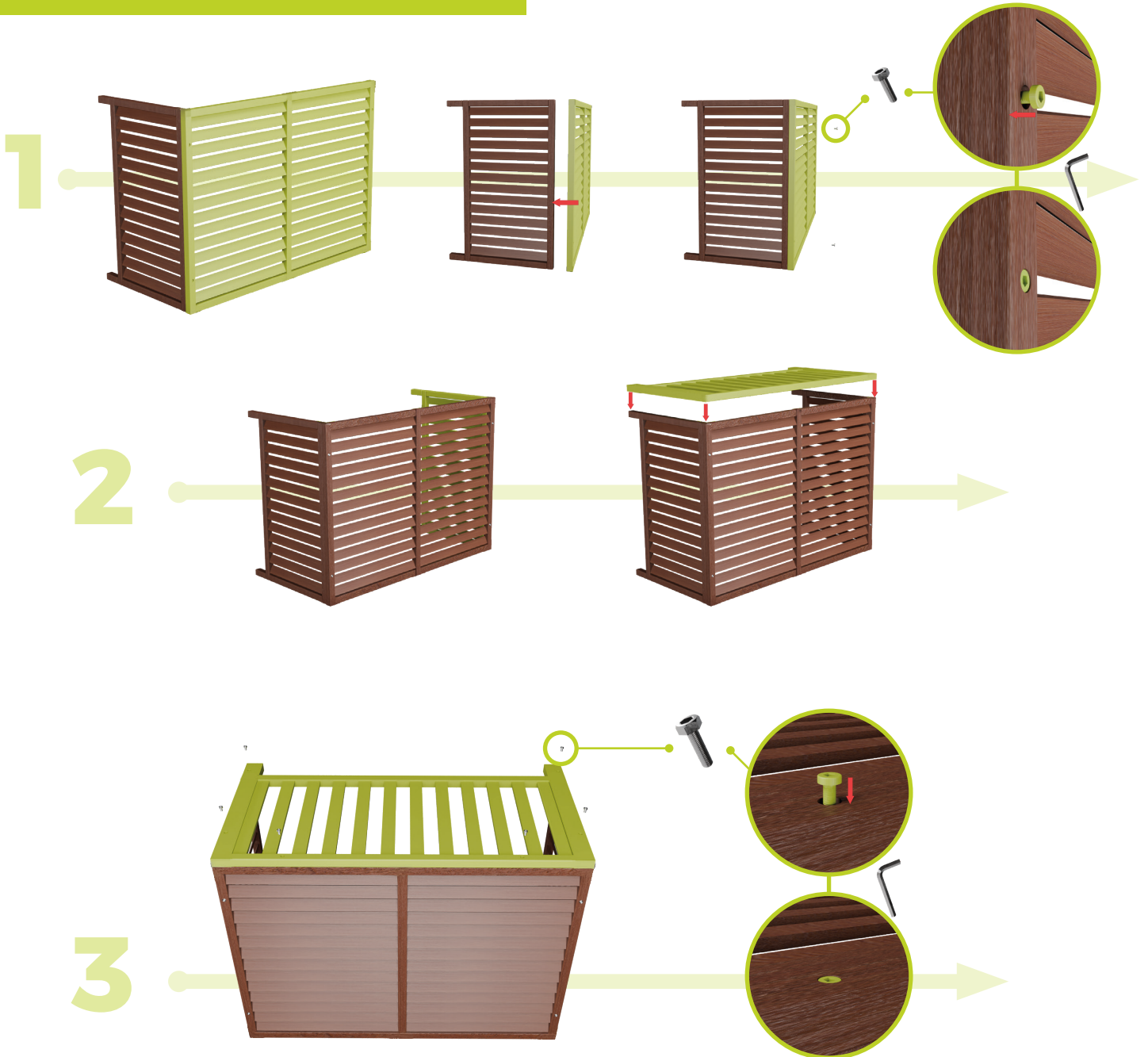

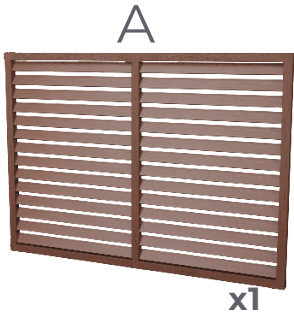

# DECO Clim

Innovation liegt in der Luft

## MONTAGE RÜCKSEITE

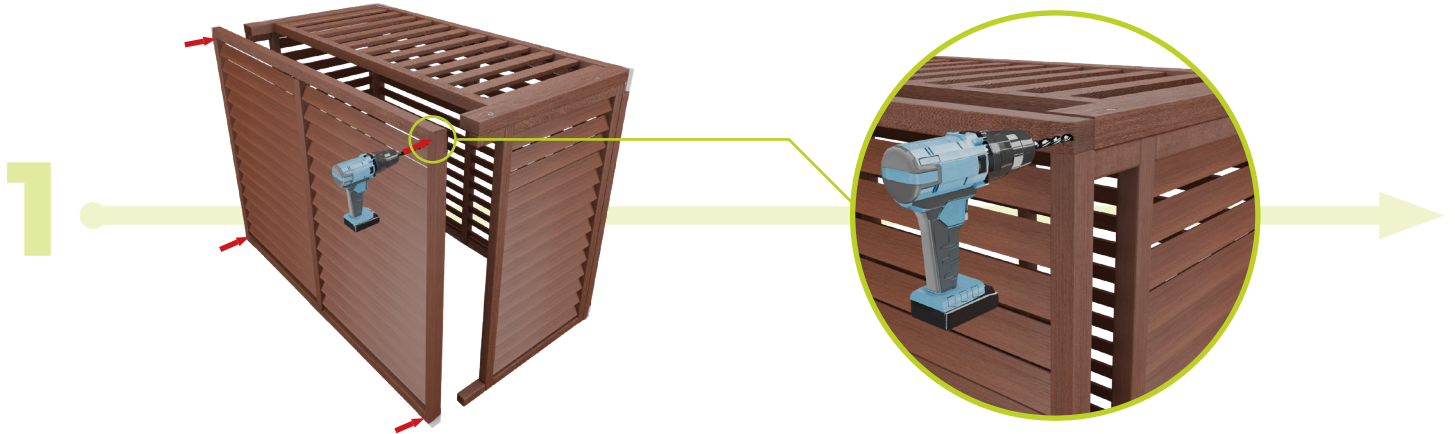

**XL**

$$A = A1 + A2$$

Bei der Grösse S ist die Vorderseite A einteilig

A1

A2

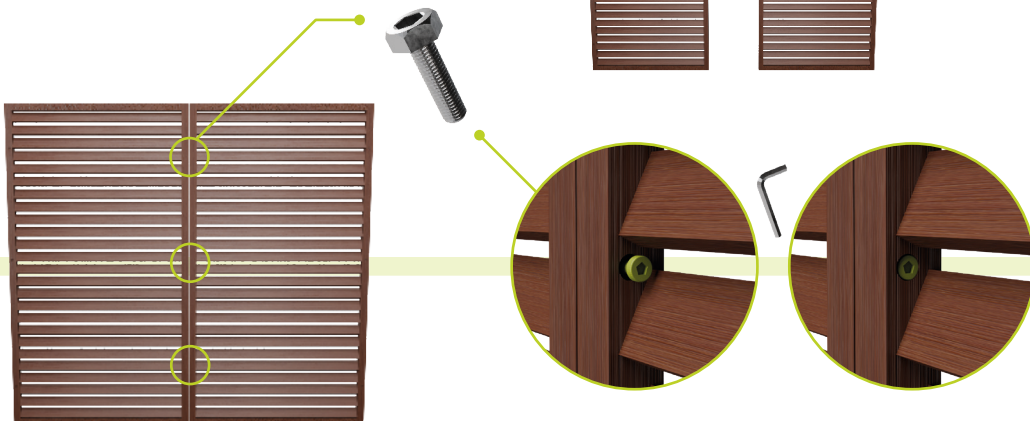



x1



x6



x1

## MONTAGE UNTERSEITE

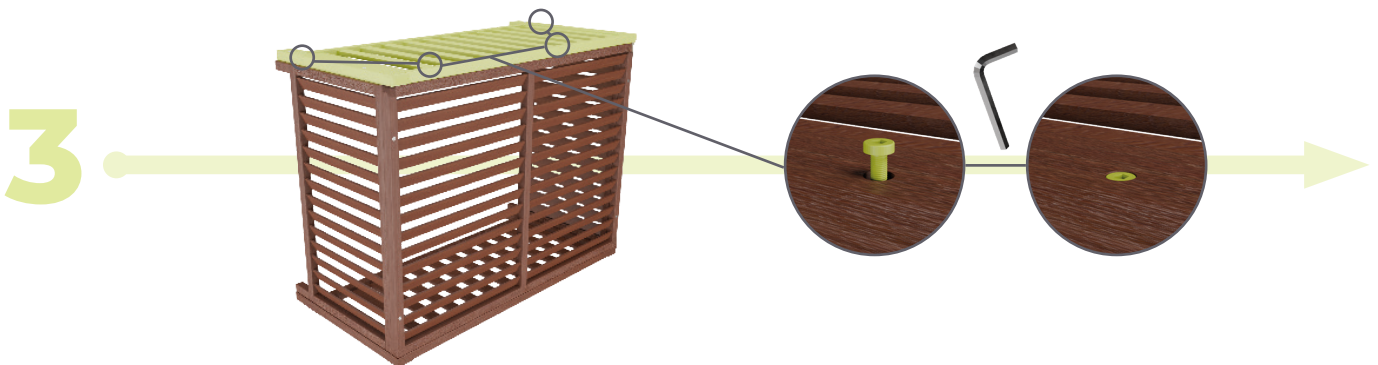
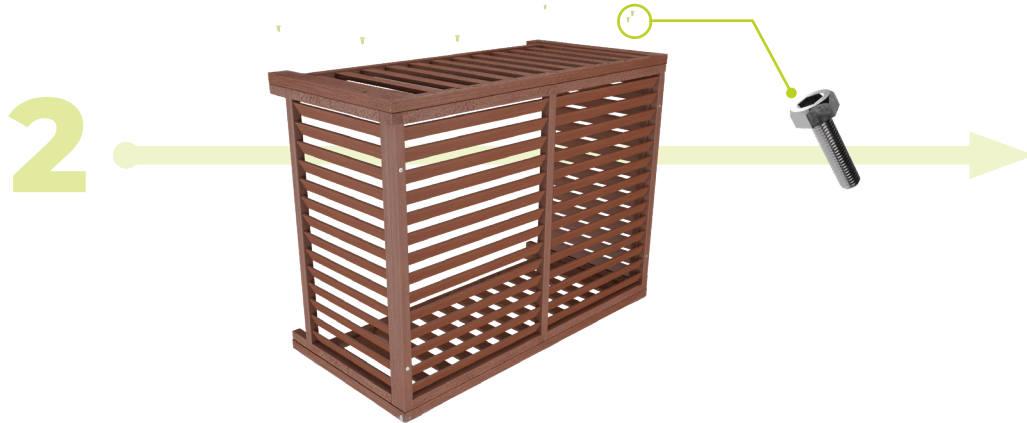
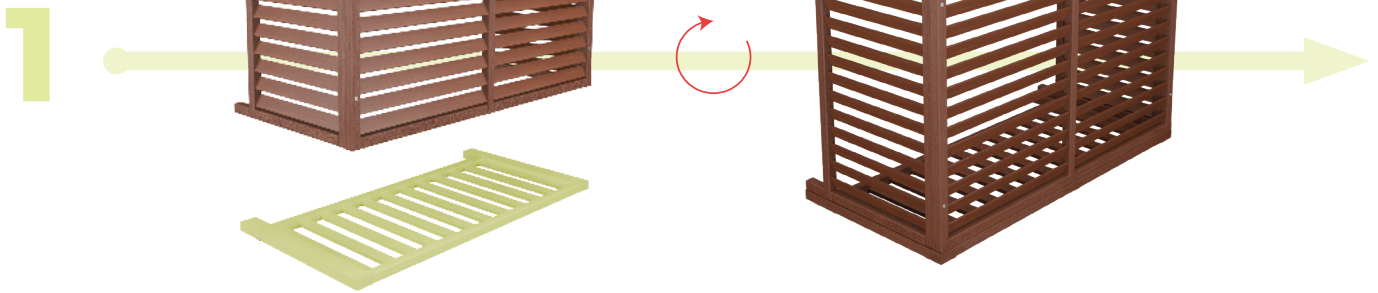

FR



## MONTAGE FÜSSE-SET / TIEFE-ERWEITERUNG

